

P2 Relay V23079

- Standard telecom relay (ringing and test access)
- Slim line 15x7.5mm (.590x.295")
- Max. switching current 5A
- 2 form C bifurcated contacts (2 changeover contacts, 2 CO)
- Immersion cleanable
- High sensitivity for low power consumption 140mW/ 70mW
- Single coil version with surge voltage resistance between contact and coil: 2.5kV (2/10µs) meets the Telcordia Requirement GR-1089, 1.5kV (10/160µs) meets FCC Part 68

Typical applications

Communications equipment linecard application (ringing and test access), PABX, voice over IP, office equipment, measurement and control equipment, automotive equipment as CAN bus, keyless entry, speaker switch, medical equipment, consumer electronics, set top boxes, HiFi

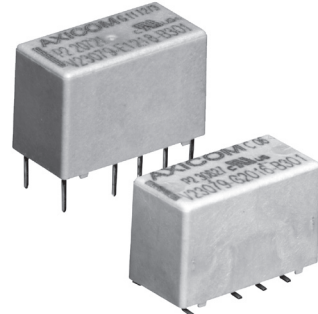

Approvals

UL 508 File No. E 111441, UL 60950, IEC/EN60950 IEC Ref. Cert. No. 327

Technical data of approved types on request

Contact Data

Contact arrangement	2 form C (CO)
Max. switching voltage	220VDC, 250VAC
Rated current	2A
Limiting continuous current, 85°C	2A
Switching Power	60W, 62.5VA
Contact material	AgNi, gold-covered
Contact style	bifurcated contact
Minimum switching voltage	100µV
Thermo-electrical potential	<10µV
Initial contact resistance	<50mΩ at 10mA, 20mV
Frequency of operation, without load	50 operations/s
Operate time	typ. 2ms, max. 4ms
Set/reset time	typ. 2ms, max. 4ms
Release time	
without diode in parallel	typ. 2ms, max. 4ms
with diode in parallel	typ. 4ms, max. 6ms
Bounce time	typ. 1ms, max. 3ms
Electrical endurance	
at 12V / 10mA	typ. 5x10 ⁷ operations
at 6V / 100mA	typ. 1x10 ⁷ operations
at 60V / 500mA	typ. 5x10 ⁵ operations
at 30V / 1000mA	typ. 1x10 ⁶ operations
at 30V / 2000mA	typ. 2x10 ⁵ operations
Contact ratings, UL	110VDC / 0.3A - 33W 30VDC / 2.0A - 60W 120VAC / 0.5A - 60VA 240VAC / 0.25A - 60VA
Mechanical endurance	typ. 100x10 ⁶ operations

Coil Data

Magnetic system	polarized
Coil voltage range	2 to 24VDC
Max. coil temperature	125°C
Thermal resistance	< 125K/W

Coil versions, monostable

Coil code	Rated voltage VDC	Operate voltage VDC	Limiting Voltage VDC	Release voltage VDC	Coil resistance Ω±10%	Rated coil power mW
008	3.00	2.25	6.50	0.30	64	140
016	4.00	3.00	8.70	0.40	114	140
011	4.50	3.38	9.80	0.45	145	140
001	5.00	3.75	10.90	0.50	178	140
002	6.00	4.50	13.00	0.60	257	140
006	9.00	6.75	19.60	0.90	578	140
003	12.00	9.00	26.15	1.20	1029	140
005	24.00	18.00	52.30	2.40	4114	140

All figures are given for coil without pre-energization, at ambient temperature +23°C. Other coil voltages on request.

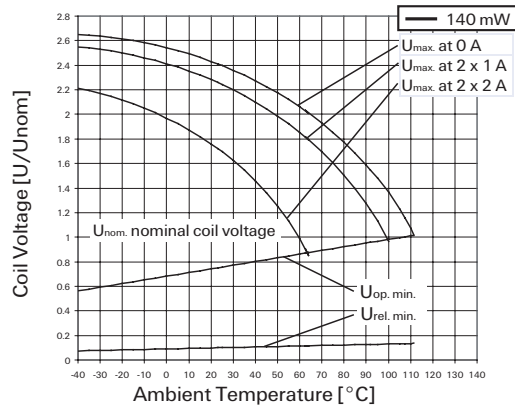

Max. DC load breaking capacity

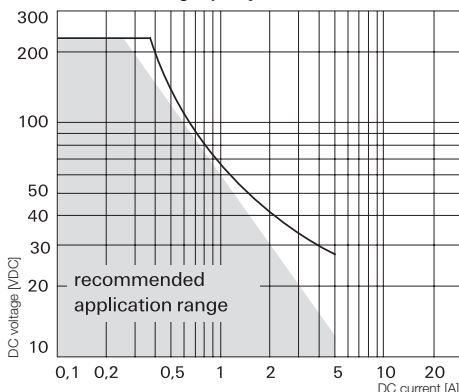

P2 Relay V23079 (Continued)

Coil Data (continued)

Coil versions, bistable

Coil code	Rated voltage VDC	Set voltage VDC	Limiting Voltage VDC	Reset voltage VDC	Coil resistance $\Omega \pm 10\%$	Rated coil power mW
Bistable, 1 coil						
108	3.00	2.25	9.2	-2.25	128	70
111	4.50	3.38	13.85	-3.38	289	70
101	5.00	3.75	15.33	-3.75	357	70
102	6.00	4.50	18.5	-4.50	514	70
106	9.00	6.75	27.75	-6.75	1157	70
103	12.00	9.00	37	-9.00	2057	70
105	24.00	18.00	74	-18.00	8228	70
Bistable, 2 coil						
219	2.00	1.50	4.33	1.50	28	140
218	2.40	1.80	5.2	1.80	41	140
208	3.00	2.25	6.5	2.25	64	140
211	4.50	3.38	9.8	3.38	145	140
201	5.00	3.75	10.9	3.75	178	140
202	6.00	4.50	13	4.50	257	140
206	9.00	6.75	19.6	6.75	578	140
203	12.00	9.00	26.15	9.00	1029	140
205	24.00	18.00	52.3	18.00	4114	140

All figures are given for coil without pre-energization, at ambient temperature +23°C. Other coil voltages on request.

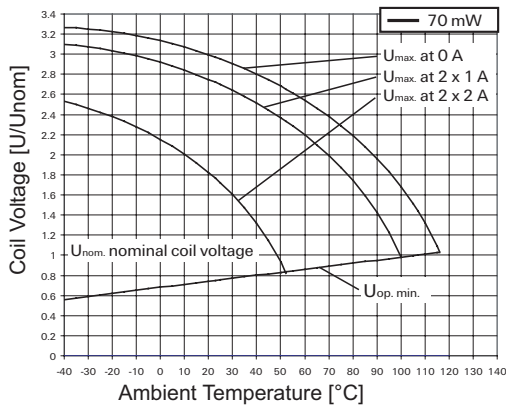

Coil versions, high dielectric version, monostable, overmolded

Coil code	Rated voltage VDC	Operate voltage VDC	Limiting Voltage VDC	Release Voltage VDC	Coil resistance $\Omega \pm 10\%$	Rated coil power mW
008	3.00	2.25	6.1	0.30	45	200
001	5.00	3.75	10.1	0.50	125	200
002	6.00	4.50	12.1	0.60	180	200
006	9.00	6.75	18.2	0.90	405	200
003	12.00	9.00	24.2	1.20	720	200

All figures are given for coil without pre-energization, at ambient temperature +23°C. Other coil voltages on request.

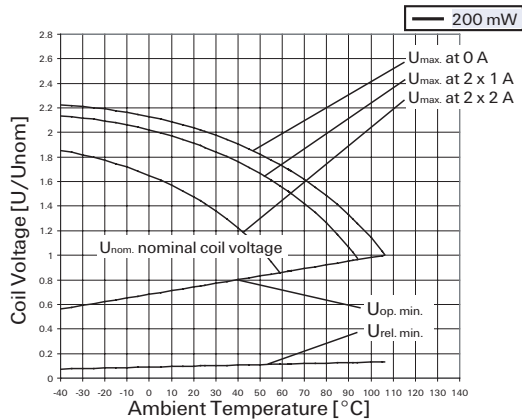

Insulation Data

	Standard	HDV
Initial dielectric strength		
between open contacts	1000V _{rms}	1500V _{rms}
between contact and coil	1500V _{rms}	1500V _{rms}
between adjacent contacts	1000 V _{rms}	1500V _{rms}
Initial surge withstand voltage		
according to Telcordia TR-NWT-001089 (2/10µs)		
between open contacts	2000V	2500V
between contact and coil	2500V	2500V
between adjacent contacts	2500V	2500V
according to (10/700 µs IEC 60950)		
between open contacts	2000V	2500V
between contact and coil	2500V	2500V
between adjacent contacts	2500V	2500V
Initial insulation resistance at 500 Vdc		
	> 10 ⁹ Ω	
Capacitance		
between open contacts	max. 1pF	
between contact and coil	max. 2pF	
between adjacent contacts	max. 1.5pF	
Clearance /creepage		
according to IEC / EN 60950	1.3/2.5mm	

Other Data

Material compliance: EU RoHS/ELV, China RoHS, REACH, Halogen content refer to the Product Compliance Support Center at www.te.com/customer-support/rohssupportcenter

Ambient temperature	-40 to +85°C
Category of environmental protection IEC 61810	RT III - wash tight
Degree of protection, IEC 60529	IP 67
Vibration resistance (functional)	35g, 10 to 1000Hz
Shock resistance (functional) IEC 60068-2-27 (half sine)	100g
Terminal type	PCB-THT, SMT long and short terminals
Weight	max. 2.8 g
Resistance to soldering heat THT IEC 60068-2-20	265°C/10s
Moisture sensitive level, JEDEC J-Std-020D related only to SMT relays packed in original dry-packs	MSL3
Ultrasonic cleaning	not recommended
Packaging/unit	
THT	box/2000 pcs.
SMT	reel/2000 pcs. or 2500 pcs.

P2 Relay V23079 (Continued)

Terminal assignment

TOP view on component side of PCB

Monostable version

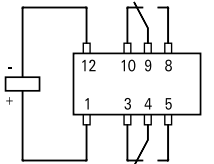

ECR0912-C

Bistable version, 1-coil

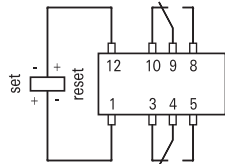

ECR0912-C

Bistable version, 2-coils

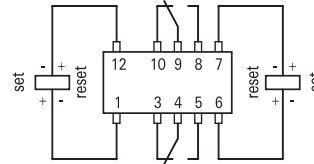

ECR0913-K

Contacts are shown in reset condition.
Both coils can be used as either set or reset coils.
Contact position might change during transportation and must be reset before use.

PCB layout

TOP view on component side of PCB

THT version

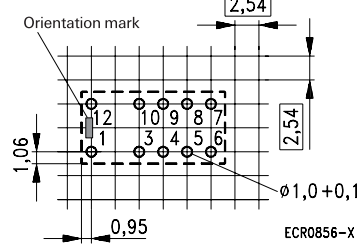

ECR0856-X

SMT, long terminals

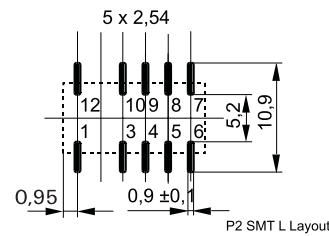

P2 SMT L Layout

SMT, short terminals

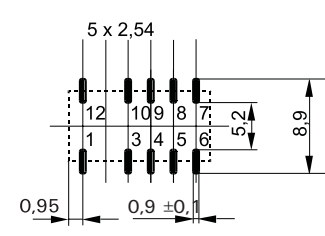

Dimensions

Standard coil
THT version

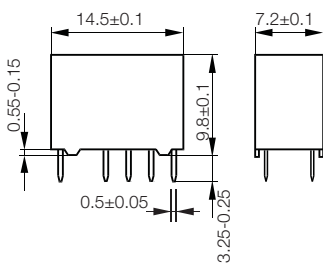

SMT, long terminals

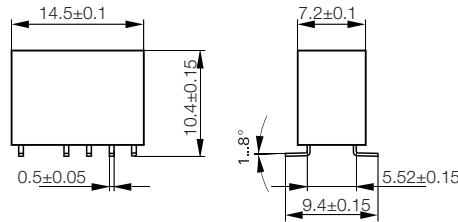

SMT, short terminals

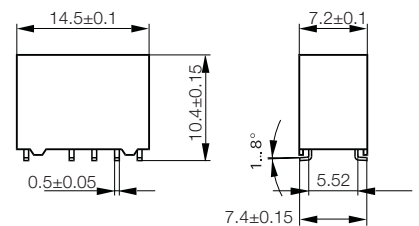

Overmolded coil, high dielectric version
THT version

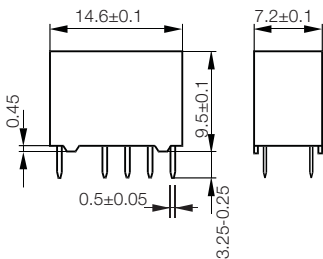

SMT, long terminals

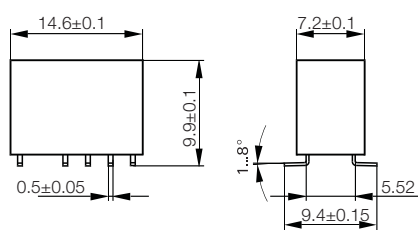

SMT, short terminals

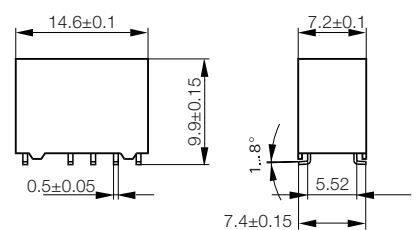

P2 Relay V23079 (Continued)

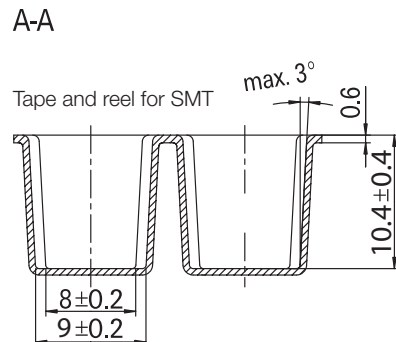
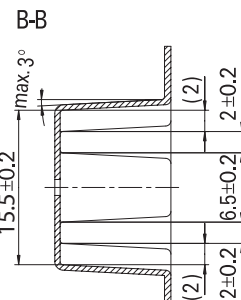
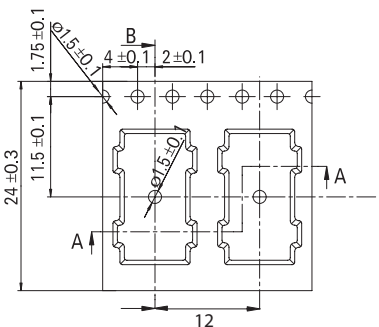
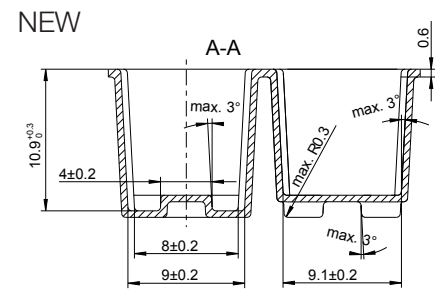
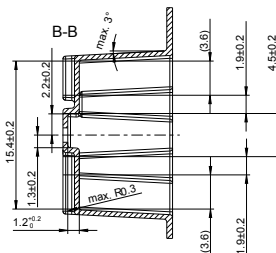
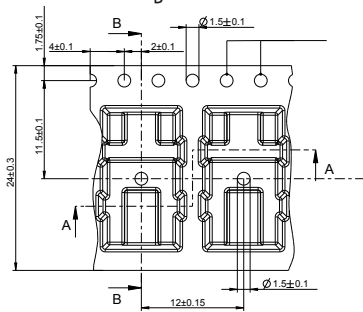
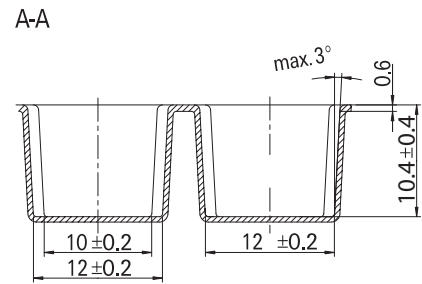
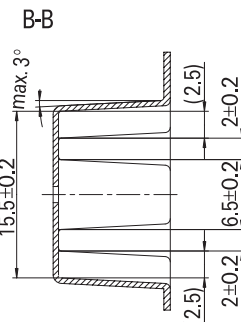
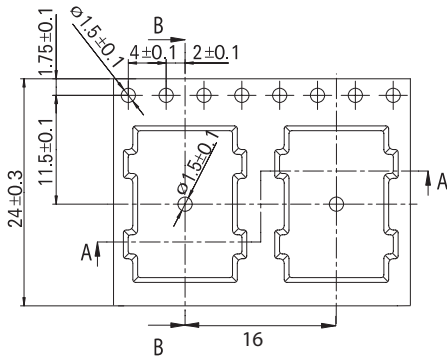
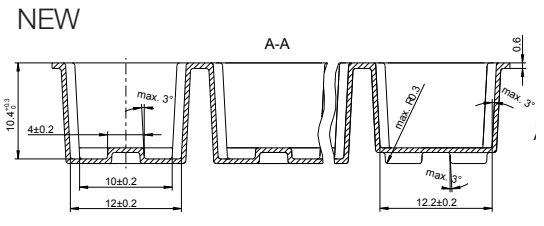
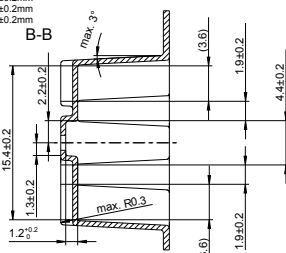
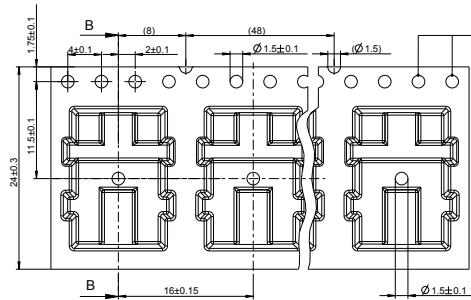
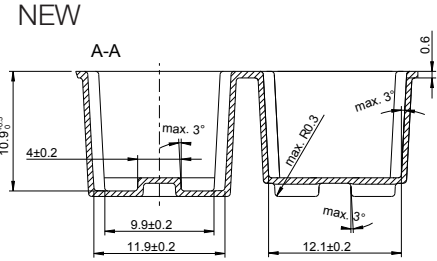
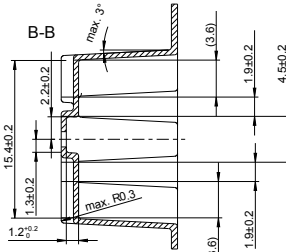
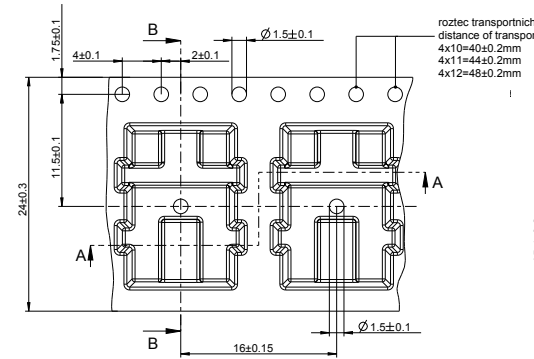

P2 Relay V23079 (Continued)

Product code structure		Typical product code		V23079	A	1	001	B	301
Type V23079 Signal Relay P2 Series									
Version									
A	THT, monostable	D	SMT, monostable, long term.	G	SMT, monostable, short term.				
B	THT, latching, 2 coils	E	SMT, latching, 2 coils long term.	H	SMT, latching, 2 coils short term.				
C	THT, latching, 1 coil	F	SMT, latching, 1 coil long term.	J	SMT, latching, 1 coil short term.				
Coil design									
1	Standard coil (not for high dielectric version)								
2	Overmolded coil								
Coil Coil code: please refer to coil versions table									
Version									
B	Standard version								
X	High dielectric version								
Contacts for standard versions									
301	2 form C contacts (2 CO), AgNi +Au								
201	2 form C contacts (2 CO), AgPd +Au; on request only								

Product code	Version	Coil design	Coil type	Coil voltage	Part number
V23079-A1006-B301				9VDC	2-1393788-0
V23079-A1005-B301				24VDC	1-1393788-6
V23079-A2008-B301		Overmolded		3VDC	6-1419120-6
V23079-A2011-B301			4.5VDC	3-1393789-9	
V23079-A2001-B301				5VDC	3-1393789-5
V23079-A2002-B301				6VDC	3-1393789-6
V23079-A2006-B301				9VDC	3-1393789-8
V23079-A2003-B301				12VDC	3-1393789-7
V23079-B1218-B301		Standard	Bistable, 2 coils	2.4VDC	1422002-8
V23079-B1208-B301				3VDC	4-1393788-1
V23079-B1211-B301				4.5VDC	4-1393788-2
V23079-B1201-B301				5VDC	3-1393788-3
V23079-B1202-B301				6VDC	3-1393788-5
V23079-B1206-B301				9VDC	3-1393788-9
V23079-B1203-B301				12VDC	3-1393788-6
V23079-B1205-B301				24VDC	3-1393788-7
V23079-B2219-B301		Overmolded		2VDC	1-1422002-2
V23079-B2218-B301			2.4VDC	1-1422002-1	
V23079-B2208-B301				3VDC	1-1422002-0
V23079-B2201-B301				5VDC	1422002-9
V23079-C1108-B301		Standard	Bistable, 1 coils	3VDC	5-1393788-3
V23079-C1111-B301				4.5VDC	5-1393788-4
V23079-C1101-B301				5VDC	4-1393788-5
V23079-C1102-B301				6VDC	4-1393788-7
V23079-C1106-B301				9VDC	5-1393788-1
V23079-C1103-B301				12VDC	4-1393788-8
V23079-C1105-B301				24VDC	5-1393788-0

P2 Relay V23079 (Continued)

Product code	Version	Coil design	Coil type	Coil voltage	Part number
V23079-D1006-B301				9VDC	5-1393788-9
V23079-D1005-B301				24VDC	5-1393788-8
V23079-D2008-B301		Overmolded		3VDC	4-1393789-7
V23079-D2011-B301				4.5VDC	4-1393789-8
V23079-D2001-B301				5VDC	4-1393789-3
V23079-D2002-B301				6VDC	4-1393789-4
V23079-D2006-B301				9VDC	4-1393789-6
V23079-D2003-B301				12VDC	4-1393789-5
V23079-E1219-B301		Standard	Bistable, 2 coils	2VDC	1-1422007-0
V23079-E1218-B301				2.4VDC	1422007-5
V23079-E1208-B301				3VDC	7-1393788-1
V23079-E1211-B301				4.5VDC	7-1393788-2
V23079-E1201-B301				5VDC	6-1393788-8
V23079-E1202-B301				6VDC	1393789-5
V23079-E1206-B301				9VDC	1393789-9
V23079-E1203-B301				12VDC	6-1393788-9
V23079-E1205-B301				24VDC	7-1393788-0
V23079-E2219-B301		Overmolded		2VDC	1422007-6
V23079-E2201-B301				5VDC	1422007-7
V23079-E2208-B301				3VDC	1422007-8
V23079-E2218-B301				2.4VDC	1422007-9
V23079-F1108-B301		Standard	Bistable, 1 coil	3VDC	7-1393788-5
V23079-F1111-B301				4.5VDC	1-1393789-4
V23079-F1101-B301				5VDC	7-1393788-3
V23079-F1102-B301				6VDC	1-1393789-0
V23079-F1106-B301				9VDC	1-1393789-2
V23079-F1103-B301				12VDC	7-1393788-4
V23079-F1105-B301				24VDC	1-1393789-1
V23079-G1005-B301	SMT, short pins		Monostable	24VDC	7-1393788-8
V23079-G2008-B301		Overmolded		3VDC	5-1393789-4
V23079-G2016-B301				4VDC	1393790-5
V23079-G2011-B301				4.5VDC	5-1393789-5
V23079-G2001-B301				5VDC	4-1393789-9
V23079-G2002-B301				6VDC	5-1393789-0
V23079-G2006-B301				9VDC	5-1393789-3
V23079-G2003-B301				12VDC	5-1393789-1
V23079-H1208-B301		Standard	Bistable, 2 coils	3VDC	2-1393789-4
V23079-H1211-B301				4.5VDC	8-1393788-4
V23079-H1201-B301				5VDC	2-1393789-0
V23079-H1202-B301				6VDC	2-1393789-1
V23079-H1206-B301				9VDC	2-1393789-3
V23079-H1203-B301				12VDC	8-1393788-3
V23079-H1205-B301				24VDC	2-1393789-2
V23079-J1108-B301			Bistable, 1 coil	3VDC	2-1393789-9
V23079-J1111-B301				4.5VDC	3-1393789-0
V23079-J1101-B301				5VDC	2-1393789-5
V23079-J1102-B301				6VDC	2-1393789-6
V23079-J1103-B301				12VDC	2-1393789-7
V23079-J1105-B301				24VDC	2-1393789-8
V23079-G2008-X079		High dielectric	Monostable	3VDC	1422006-5
V23079-G2001-X071		Overmolded		5VDC	1422006-1
V23079-G2002-X072				6VDC	1422006-2
V23079-G2006-X073				9VDC	1422006-3
V23079-G2003-X074				12VDC	1422006-4
V23079-A2003-X074				12VDC	1422025-7
V23079-A2008-X079				3VDC	1-1422025-1